

Article number: 2314452798

Description: E+G polyurethane wheel 452798  
RE.G5-82x90-RSL - Loose wheel with ball bearings

## Measures

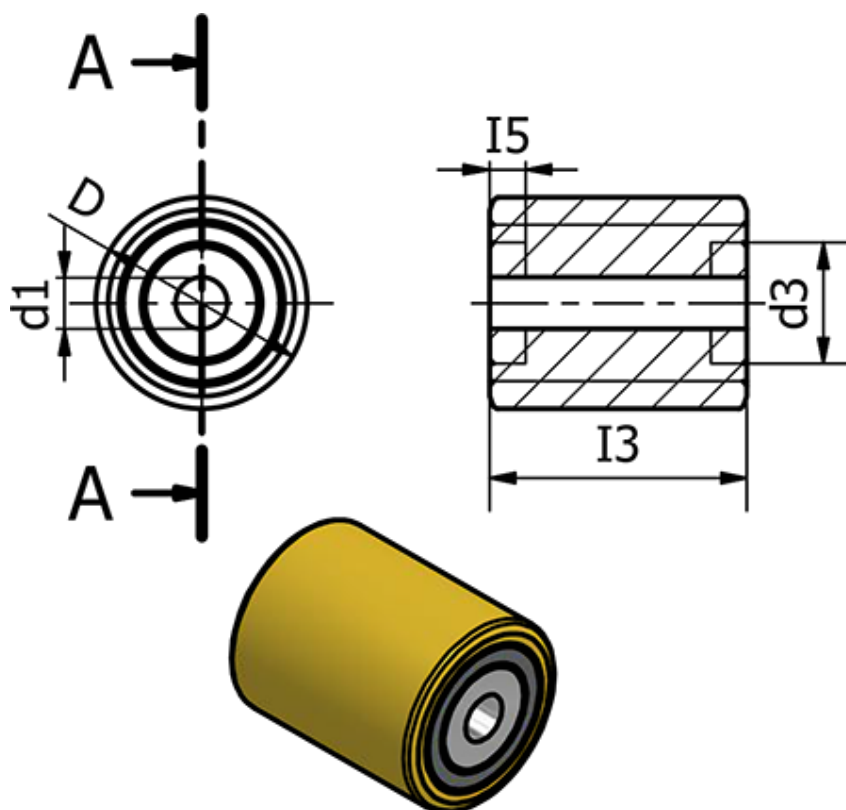

Code	= 452798	Static load (N)	= 10000
D	= 82	Type	= RE.G5-82x90-RSL
d1	= 20	Weight (g)	= 1330
d3	= 47		
Dynamic carrying capacity (N)	= 9000		
I3	= 90		
I5	= 14		
Rolling resistance (N)	= 3400		